

LIGHT-CURING EQUIPMENT SELECTOR GUIDE



Only Dymax offers expert knowledge of light-cure technology, along with a full array of light-cure products. Dymax is committed to developing a true collaborative partnership — applying our extensive process knowledge to your specific application challenges.

Because we understand the process as a whole, and not just individual aspects of it, we can offer our customers a solution where chemistry and equipment work seamlessly together with maximum efficiency.

Our application engineering team works side-by-side with customers, providing assistance with product and process design, testing, evaluation, and pre-production trials throughout the life of the assembly process.

SPOTS | FLOODS | CONVEYORS | RADIOMETERS | ACCESSORIES



Dymax Light-Curing Technology

For more than 40 years, light-curing technology has allowed manufacturers to lower processing costs, produce higher quality products, and eliminate the use of harmful chemicals from the workplace. First introduced in the early 1980s for ink and thin coating applications, the technology has advanced tremendously over the last three decades, becoming the method of choice for many other industrial bonding, sealing, coating, potting, and tacking applications.

Light curing's popularity stems from its ability to deliver fast, durable bonds in seconds, on demand. Faster on-demand cures result in more efficient manufacturing processes by providing shorter cycle times, reduced labor costs, and reduced work-in-progress. In addition to its efficiency, light-curing technology is also environmentally and worker friendly. It utilizes no explosive equipment, is associated with fewer health issues, and requires lower regulatory and disposal costs than other technologies.

Dymax has specialized in light-curing assembly solutions since the introduction of the technology. Today, we offer the broadest range of light-curable materials available and a complete line of conventional and LED light-curing equipment. Our light-curing equipment offers manufacturers safe, reliable curing in a number of different configurations including spot, flood, and conveyor systems.

About This Guide

This selector guide provides an overview of Dymax light-curing systems. Additional information for all systems is available on our website at dymax.com. For answers to your specific application questions, please contact our Application Engineering team. They are available to help recommend a light-curable material and design a dispensing and curing process for your specific application. Whenever possible, our Application Engineers will also conduct testing on your specific parts to ensure the chosen products meet all application requirements. If testing indicates our standard formulations or light-curing systems are not suitable, our Application Engineers can also help you find an alternative solution for your assembly process.

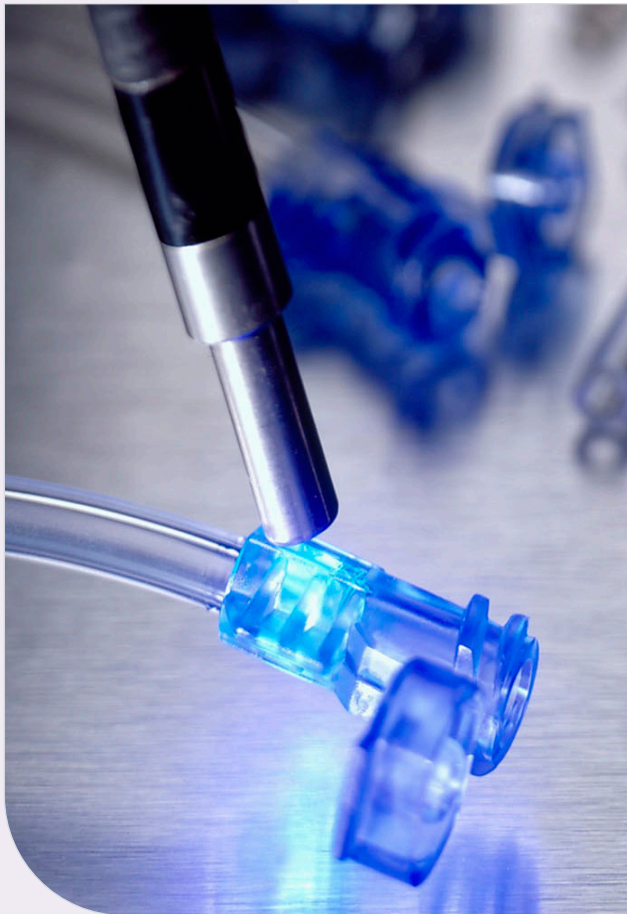

UV Broad-Spectrum & LED Spot-Curing Systems

Spot-cure systems deliver optimized curing energy to a very precise location. They can be used manually by an operator in a turnkey bench-top system or incorporated into a high-speed automated assembly line. They are ideal for curing small areas quickly in R&D laboratory environments as well as low- and high-volume production applications in the medical, industrial, electronics, automotive, and optical industries.

Dymax spot systems are worker friendly, utilizing an integral timed/manual closure control and typically requiring little external shielding. Dymax systems also feature a patented intensity adjustment feature which aids users in both validating and controlling the light-curing process. Dymax spot systems are designed with either arc lamp or LED energy sources.

Conventional Arc Lamp Spot-Curing Systems

Dymax multi-spectrum spot lamps cure using high-pressure metal-halide lamps that produce light energy in the 300 to 450 nm range. These spot lamps can be equipped with rod lenses or single- or multiple-pole lightguides in various diameters (3, 5, and 8 mm) and lengths (up to 3 meters) for a variety of curing options.

LED Spot-Curing Systems

Dymax LED spot-curing systems generate curing energy using an array of surface-mounted LEDs instead of traditional metal halide or mercury bulbs. They are semiconductor energy sources that emit very discrete wavelengths of energy, resulting in a single, narrow, bell-shaped emission spectrum.

These units offer cooler cures compared to traditional lamp-style curing systems as well as longer service life that eliminates lamp replacement and reduces maintenance costs, higher electrical efficiency and instant on/off capability that lowers operating costs, and "green" attributes that eliminate mercury and ozone safety risks and handling costs.

BlueWave® 200 Version 3.1

The BlueWave® 200 3.1 is a high-intensity, light-curing spot-lamp system. This spot-curing lamp emits energy in the UVA and visible portion of the spectrum (300-450 nm) for light curing of adhesives, coatings, and encapsulants. Ideally suited for either manual or automated processes, the unit contains an integral shutter which can be actuated by a foot pedal or PLC and a universal power input (100-240 V, 50-60 Hz) that provides consistent performance at any voltage. A wide range of lightguides in various materials and configurations are available for use with this unit, providing application flexibility.

The BlueWave 200's faceplate design features an improved operator interface with an easy-to-read LCD display. Also located on the faceplate is the unit's patented intensity adjustment control. This feature is important for validating an appropriate intensity range and maintaining that range during production. Users can manually adjust the unit's intensity to accommodate for bulb degradation and other factors that may affect intensity.

- Manual intensity adjustment, >17,000 mW/cm² initial intensity
- Large, easy-to-read front panel LCD display
- Improved user interface for easier operation
- Extended exposure time settings to 9,999.9 seconds
- Controlled power-up sequence ensures proper temperature

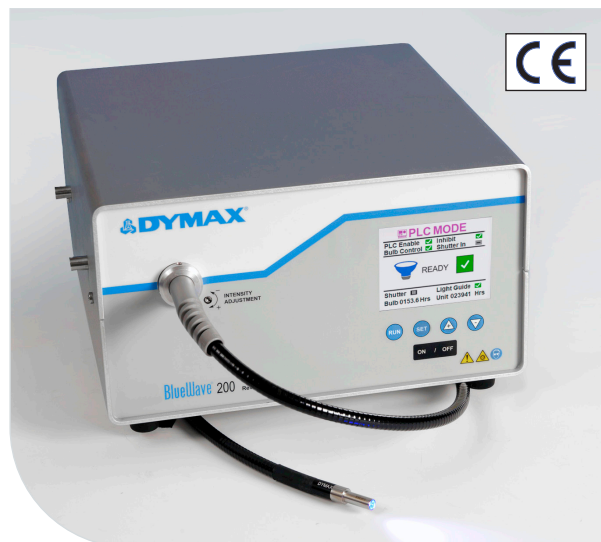

Part Number	41013 BlueWave 200 Version 3.1
-------------	--------------------------------

NOTE: The appropriate power cord for the location will be added prior to shipment.

BlueWave® MX-150

This curing system provides manufacturers with the curing flexibility they need, in a smaller, more efficient design. The unit is comprised of two main parts, a controller with an easy-to-use touchscreen interface and a high-intensity LED emitter which is uniquely designed to offer higher, more consistent curing intensity than traditional spot-curing systems. Curing energy is created using an LED chip in the emitter, unlike traditional spot-cure systems, where it is located in the controller. Locating the LED chip at the point-of-cure provides more consistent curing by addressing potential intensity loss caused by the use of long or bent lightguides.

With this new design, the system can be truly tailored to users' curing needs – allowing them to choose from three different wavelength LED emitters (365, 385, or 405 nm) so optimal cures are achieved. Users also have endless set up flexibility; for automated curing processes, the emitter can be easily mounted to robotic arms or further from the controller without fear of intensity variations. When used as a bench-top curing system, the unit can be paired with a stand and shielding or a Wolf-style lightguide can be connected to the system for specialized applications.



- High intensity of up to 40 W/cm² for faster curing
- Touchscreen interface for easier operation
- Emitter design for set up flexibility and consistent intensity
- LED emitters in 365, 385, and 405 nm wavelengths
- Admin and production modes with the ability to save curing programs for repeated use
- Instant on/off for a more energy efficient unit with no warm-up period
- PLC interface that is easily incorporated into automated systems

A complete BlueWave MX-150 system features a controller and an LED emitter. Components are sold separately. Wolf-style lightguides and other accessories can be added for specific applications. See pages 7 and 8 for additional accessories.

	PrimeCure® 385 nm	VisiCure® 405 nm	RediCure® 365 nm
LED Emitter*	42337	42338	42336
Controllers	43184 BlueWave® MX-Series 2-Channel Controller Only 43181 BlueWave® MX-Series 4-Channel Controller Only 43299 BlueWave® MIM Machine Interface Module Only		
Accessories	36987 5-mm Lightguide Simulator 41148 Adjustable Taper Shoulder Focusing Lens (5 mm)		
Interconnect Cables	43453 Interconnect Cable Assembly (12 inches) 42287 Interconnect Cable Assembly (2 meter) 42889 Interconnect Cable Assembly (5 meter) 43010 Interconnect Cable Assembly (10 meter) 43011 Interconnect Cable Assembly (20 meter)		

* Note: 5-mm lightguide simulator comes with every emitter NOTE: The appropriate power cord for the location will be added prior to shipment.

BlueWave® QX4 V2.0

The BlueWave® QX4 V2.0 high-intensity spot-curing system features all the benefits of LED-curing technology in a smaller, more versatile unit. This system is comprised of a controller and up to four LED heads. LED heads are available in 365, 385, and 405 nm and can be outfitted with 3-, 5-, or 8-mm diameter focusing lenses. LED heads and focusing lenses can be used in any combination and can be controlled through the system's variable mode, a feature that allows each head to be individually programmed for intensity and cycle times. Individual exposure times and intensity settings can be set in 1% increments for each LED head, giving users maximum curing flexibility.

In addition to its curing flexibility, the system also features an easy-to-use control interface that allows flexibility in setup and use of the unit. The unit can be activated by touchscreen, foot pedal, or through an I/O interface connection, allowing it to be easily incorporated into automated systems.



- One controller controls up to four LED heads, which can be programmed independently
- LED heads in 365, 385, or 405 nm wavelengths
- Interchangeable/replaceable focusing lenses in 3-, 5-, and 8-mm diameters
- Instant on/off for a more energy efficient unit with no warm-up period
- Efficient LED-head temperature management
- PLC interface that is easily incorporated into automated systems

A complete BlueWave QX4 V2.0 system features a controller and up to four LED heads/lenses. Each LED head must have a lens in order to operate properly. Components are sold separately.

	RediCure® 365 nm	PrimeCure® 385 nm	VisiCure® 405 nm
LED Head	88807	88808	88809
Controller Only	88825 with Europe Power Cord (Type F) 88826 with UK/Asia Power Cord (Type G) 88828 with No Power Cord*		
Lens Only	81205 3-mm Lens 81206 5-mm Lens 81207 8-mm Lens		
Cable Extensions	84125 1.0 M Extension 84127 2.0 M Extension		
Accessories	88821 Mounting Clamp Kit 88822 Connection Clamp 81208 Mounting Clamp Extension Kit		

*The appropriate power cord for the location will be added prior to shipment.

Lightguides

Lightguides transmit UV and visible energy from a source mounted inside of a spot-curing unit to the curing area. When choosing a lightguide for your system, the following factors should be considered:

Length – Lightguides are commonly one meter long although other lengths are available.

Diameter – Single-pole lightguides are available with 3-mm, 5-mm, or 8-mm inside diameters. Although the 5-mm lightguide will register a higher intensity, the 8-mm lightguide provides more curing power (intensity x area) because a larger lightguide opening captures more of the light emitted from the bulb. Each pole of a multi-pole lightguide has an inside diameter of 3 mm.

Multiple Poles – Light emitting from a spot lamp can be channeled through a single lightguide (single pole) or split between multiple lightguides (multiple poles). Each pole of a multi-pole lightguide emits equal intensity (typically $\pm 10\%$ for liquid-filled lightguides) and all share a common shutter. Both liquid-filled and quartz-fiber multi-pole lightguides are available from Dymax.

Connection – There are basically two types of connectors used in the spot lamp industry, “Wolf” and “D” connectors. Dymax provides lightguides with both connector types, although “D” connectors are an industry standard and compatible with current Dymax lamp designs (older Dymax designs utilized “Wolf” connectors).

Curing Area/Intensity vs. Distance – The UV and visible light emitted from a lightguide diverges. As a result, intensity decreases and curing area increases with distance from the end of the light guide. The chart to the right describes this relationship clearly for the 5-mm liquid lightguide.

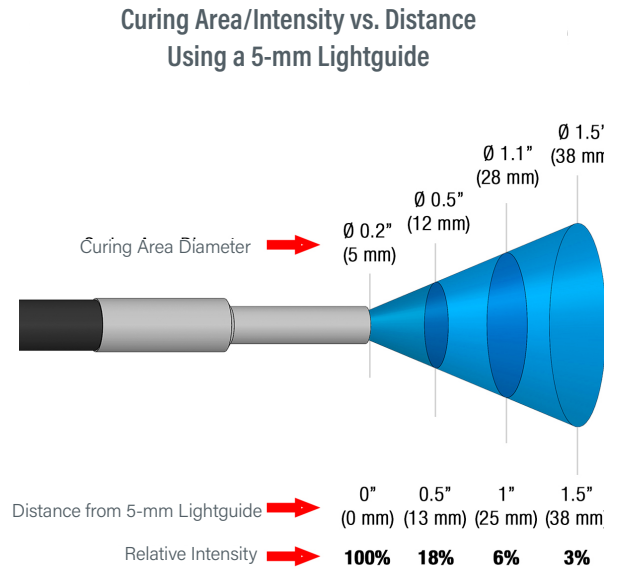

Part Number	Lightguide Description (all noted are liquid filled; quartz fiber are also available)	Compatible Dymax Systems
5720	Single Pole 5 mm x 1 M	BlueWave® 75 BlueWave® 200 BlueWave® LED Prime UVA BlueWave® LED VisiCure® BlueWave® DX-1000 BlueWave® DX-1000 VisiCure®
5721	Single Pole 5 mm x 1.5 M	
5722	Single Pole 8 mm x 1 M	
38476	Two Pole 3 mm x 1 M	
38477	Three Pole 3 mm x 1 M	
38478*	Four Pole 3 mm x 1 M	Compatible with All BlueWave® Spot Lamps
36619	Single Pole - Wolf Style 3 mm x 1 M	BlueWave® MX-150
37043	Two Pole - Wolf Style 3 mm x 1 M	
35101	Single Pole - Wolf Style 5 mm x 0.5 M	
35102	Single Pole - Wolf Style 5 mm x 1 M	
36238	Single Pole - Wolf Style 5 mm x 1.5 M	
38998	Single Pole - Wolf Style 5 mm x 2 M	
38676*	Four Pole - Extended Range 3 mm x 1 M	
38851*	Four Pole 3 mm x 1.5 M	
39791*	Four Pole - Fiber Optic 3 mm x 1 M	

*Lightguide adapter conversion kit (PN 42932) required for use with BlueWave MX-150.

Accessories

Lightguide Mounting Stands

39700 Single Lightguide Mounting Stand

Utilizes a 24" flexible arm for mounting 3, 5, and 8-mm lightguides. This stand offers a 5" x 5" (127 mm x 127 mm) working area and allows repeatable, hands-free spot curing.

41325 Acrylic Lightguide Mounting Stand

Multiple lightguides can be securely mounted on this stand for repeatable, hand-free spot curing.

41595 Lightguide Stand Expansion Kit

Allows the Dymax acrylic lightguide mounting stand to hold up to four lightguide poles.



Single Lightguide Mounting Stand

Rod Lenses

Turn a spot into a flood lamp with shutter! A rod lens re-focuses the UV light emitted from a spot lamp to create a very uniform (<5% variation) 2" x 2" (50.8 mm x 50.8 mm) or 5" x 5" (127 mm x 127 mm) curing area. These rod lenses attach to the UV light-curing spot system using an 8-mm lightguide (sold separately).

38699 Rod Lens, 2" x 2" (50.8 mm x 50.8 mm) Area

38698 Rod Lens, 5" x 5" (127 mm x 127 mm) Area

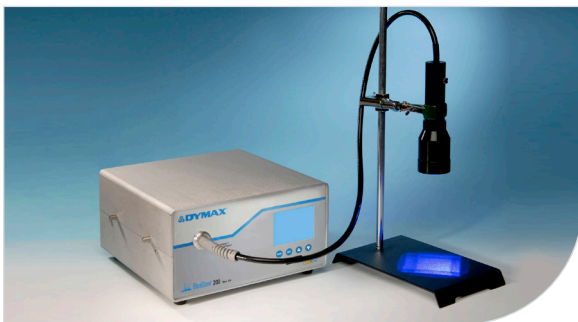

BlueWave® 200 with Rod Lens

Lightguide Terminators

Lightguide terminators can be attached to the end of a lightguide to help users get UV light to those difficult-to-reach locations.

39029 3 mm/60°

39030 3 mm/90°

38042 5 mm/60°

38049 5 mm/90°

39334 8 mm/60°

39333 8 mm/90°



Lightguide Simulators

A lightguide simulator can be used to accurately measure the direct light intensity from the system's energy source.

38408 Lightguide Simulator, 7-mm Diameter

36987 Lightguide Simulator, 5-mm Diameter

Emitter Stands & Shields

42390 BlueWave® MX-Series Mounting Stand

Mounting stand with adjustable height for a single MX-series emitter.

43019 BlueWave MX-Series Single Emitter Mounting Kit

Mounting adapter for attaching MX-series emitters.

43070 BlueWave MX-Series Multi-Array Mounting Stand

Accommodates up to 4 MX-series emitters.

42426 Single Emitter Mount for MX Controller

Securely mount an emitter to the side of the BlueWave MX-150 controller for configurations using a lightguide.

60868 Dual Emitter Mount for MX Controller

Securely mount up to two emitters to the side of the MX controller.

41395 Three-Sided Acrylic Shield

Compatible with the BlueWave MX-150. A simple and cost effective three-sided shield that is removed manually.



UV Broad-Spectrum & LED Flood-Curing Systems

Flood-style curing systems usually provide moderate to high-intensity light. These units have the advantage of being able to cure a tray of parts, or parts with large bonded or coated areas. These kinds of lamps are commonly integrated into existing manufacturing processes by mounting them above high-speed assembly lines. Fairly deep cures can be achieved by these relatively inexpensive units at 10- to 30-second exposure times. Wide-area flood lamps are used successfully to cure substrates that are somewhat heat-sensitive, such as certain plastics.

Dymax currently offers both broad-spectrum and LED flood curing systems to fit a wide variety of curing applications. Shutter assemblies, mounting stands, shields, and other accessories are available to order to create custom bench-top curing systems. CE marked units are available for manufacturers in Europe.

Broad-Spectrum Flood Lamps

Dymax broad-spectrum flood curing systems use moderate- to high-intensity (105-225 mW/cm²) UV/visible light to cure UV light-curable adhesives, coatings, and inks in as little as 5-30 seconds. Systems are available with 5" x 5" (127 mm x 127 mm) or 8" x 8" (203 mm x 203 mm) curing areas. They come standard with a 400 watt metal-halide bulb but can be outfitted with longwave, shortwave, UV, and visible replacement bulbs to fit unique applications. All bulbs have a long service life and come with a 2,000 hour warranty.

LED Flood Curing Systems

Dymax LED flood lamp systems use high-intensity LEDs to cure a 5" x 5" (12.7 cm x 12.7 cm) area. Because these flood systems use a high-intensity LED as the curing source they produce faster cure times, more consistent frequency and intensity output, a cooler curing environment for thermally sensitive substrates, and longer bulb life than conventional arc lamps. Systems are available in three different wavelength arrays (365, 385, and 405 nm) so users can fully optimize the curing process between their light-curable material and the curing system. costs, and "green" attributes that eliminate mercury and ozone safety risks and handling costs.

ECE-Series Flood Lamp Systems

Dymax UV light-curing flood-lamp systems are ideal for light curing large parts or curing many small parts simultaneously. With intensities ranging from 105-225 mW/cm², Dymax flood lamps are capable of curing most UV light-curable adhesives, sealants, and coatings, tack free in 30 seconds or less. These flood lamps can be incorporated into automated assembly systems or mounted onto conveyors. Dymax flood units can also be used as turnkey bench-top units (with optional shutters).

- Large curing area, 5" x 5" (12.7 cm) or 8" x 8" (20.3 cm)
- Adjustable lamp height
- 100% shielding with safety interlock kit
- Two bulb options: shortwave or longwave
- Extended exposure time settings to 9,999.9 seconds
- Controlled power-up sequence ensures proper temperature

	ECE 2000	ECE 5000
Typical Intensity Output*	105 mW/cm ²	225 mW/cm ²
Curing Area	8" x 8" (20.3 cm x 20.3 cm)	5" x 5" (12.7 cm x 12.7 cm)
Working Distance	2"-6" (5.08 cm - 15.24 cm)	
Typical Degradation	<20% over 2,000 hours	
Power Requirements	100-240 VAC, +/- Single Phase 50-60 Hz	

* Intensity readings vary widely depending on the make and model of the radiometer. These intensities were measured with the ACCU-CAL™ 50 radiometer.

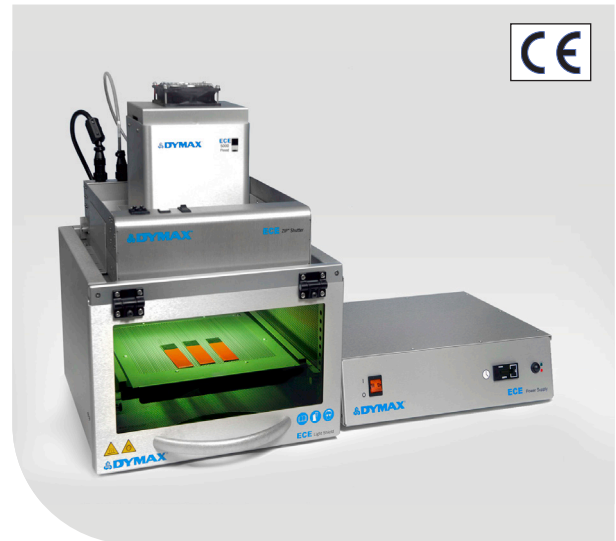

ECE 5000 Shown with ZIP™ Shutter & Light Shield

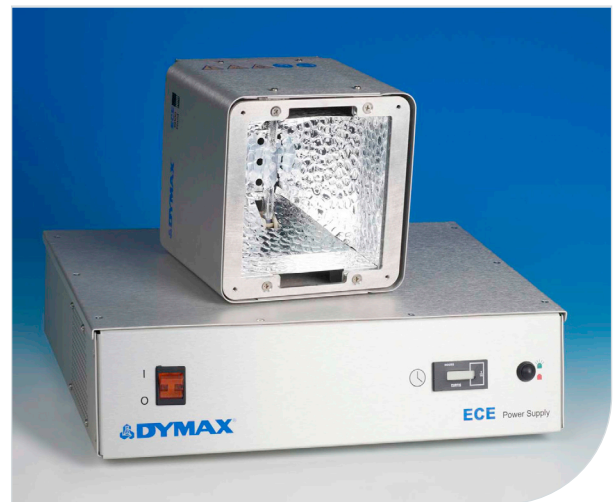

Modular ECE 5000

	ECE 2000 (8" x 8" (20.3 cm x 20.3 cm))	ECE 5000 (5" x 5" (12.7cm x 12.7cm))
Modular (No Shielding or Shutter)	40965	40915
With Mounting Stand	40920	40970
With ECE Light Shield	40870	40900
With ECE Light Shield & Manual Shutter	40790	40850
With ECE Light Shield & ECE ZIP™ Shutter	40830	40840

NOTE: The appropriate power cord for the location will be added prior to shipment.

BlueWave® AX-550 V2.0

The BlueWave® AX-550 combines a controller, emitter, and power supply into a compact, all-in-one LED flood-curing system. Eliminating the need for a large, traditional-style controller and bulky cables, this unit has a greatly reduced footprint and is easily integrated into automated processes.

The system features a large 5" x 5" (12.5 x 12.5 cm) curing area, which is controlled by an easy-to-navigate user interface with push-button controls or through a PLC interface. Dymax offers the system with three different wavelength emitters (365, 385, and 405 nm), which are field-upgradable by customers so they can switch to another wavelength easily if needed.

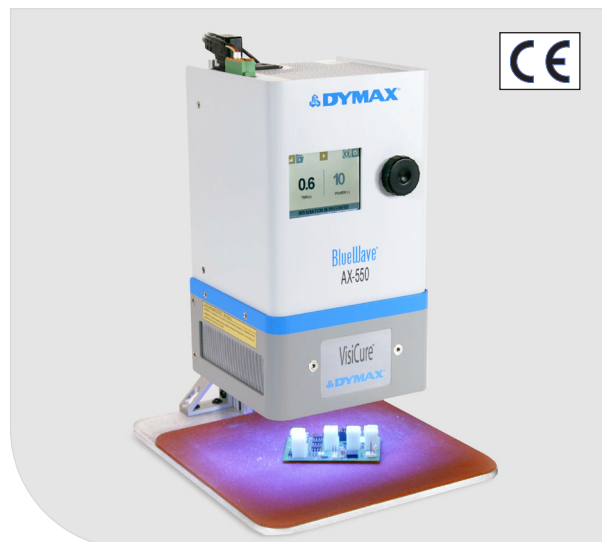

	RediCure 365 nm	PrimeCure 385 nm	VisiCure 405 nm
Typical Intensity Output, mW/cm ² *	650	800	800
Dimensions (H X W X D)	6.54" x 11.41" x 6.75" (166 mm x 290 mm x 171 mm)		
Curing Area	5" x 5" (12.5 cm x 12.5 cm)		
Power Requirements	100 - 240 VAC 50/60 Hz (Auto-Ranging)		

* When measured at 25-mm distance with an ACCU-CAL™ 50-LED radiometer in flood mode.

- Large curing area, 5" x 5" (12.5 cm) active area
- All-in-one design for small footprint and no bulky cables
- User interface with touchscreen and rotary push button control
- Emitters available in 365, 385, and 405 nm wavelengths
- Unit can be used as a bench-top cure system or incorporated into an automated process or conveyor
- Direct-to-frame pre-drilled holes for stability and easy mounting and integration into automated systems
- PLC interface that allows for control and monitoring of power levels, exposure times/routines, and system health and safety lockout

	RediCure (365 nm)	PrimeCure (385 nm)	VisiCure (405 nm)
Part Number	60877	60880	60883

NOTE: The appropriate power cord for the location will be added prior to shipment.

BlueWave® FX-1250

The BlueWave® FX-1250 is a high intensity flood-curing system that delivers true, high-irradiance LED light for better speed, depth, and fullness of cure. The system provides the best cure by combining intensities of over 2 W/cm² with a 5" x 5" (12.7 cm x 12.7 cm) curing area and high uniformity.

The BlueWave® FX-1250 is comprised of a controller and up to two LED emitters. The controller features a 7" touch screen with an intuitive, easy to use interface. It can be activated, controlled, and remotely monitored by PLC, and also store programs and parameters for repeatable processes. The controller also continuously monitors the health of the system. LED emitters are available in three wavelengths for greater curing flexibility.

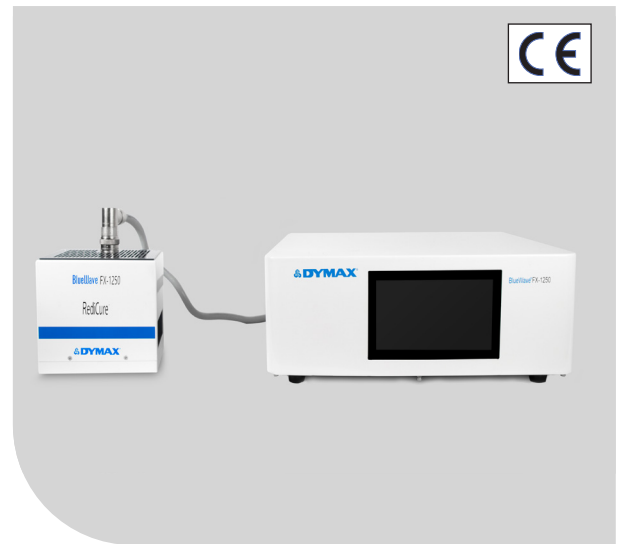

	RediCure® 365 nm	PrimeCure® 385 nm	VisiCure® 405 nm
Typical Intensity Output, mW/cm²*	1700	2100	2000
Dimensions (W X H X L)	Emitter: 6.7" x 5.3" x 6.4" (170 mm x 134 mm x 162 mm) 1CH Controller: 4.5" x 13" x 18.25" (11.4 cm x 33.0 mm x 46.4 cm) 2CH Controller: 16.5" x 13.8" x 5.8" (420 mm x 350 mm x 165 mm)		
Curing Area	5" x 5" (12.7 cm x 12.7 cm)		
Power Requirements	100-240 V≈ 10 Amps, 50-60 Hz		

* When measured at 25-mm distance with an ACCU-CAL™ 50-LED radiometer in flood mode.

- Large curing area, 5" x 5" (12.7 cm x 12.7 cm)
- Excellent uniformity and higher intensity
- LED emitters available in 365, 385, and 405 nm wavelengths 7" Touch screen interface
- 1 & 2 Channel Controller Options
- PLC activation and control
- Greener technology - no ozone generation, mercury free, & lower energy consumption than conventional lamps
- Fully programmable with capability to store up to 16 programs
- Unit can be used as a bench-top cure system or incorporated into an automated process or conveyor

The BlueWave® FX-1250 is sold as a complete system or as separate components. Other accessories can be added for specific applications. See page 15 for additional accessories.

	RediCure® (365 nm)	PrimeCure® (385 nm)	VisiCure® (405 nm)
LED Emitter	88801	88802	88803
Controller	88850 1-Channel Controller* 88851 2-Channel Controller*		
Complete System (1CH Controller, Interconnect Cable, 1X Emitter, Foot Switch, Power Cord)	88856*	88857*	88858*
Interconnect Cables	84025 Type L & L 84026 Type I & L		

*NOTE: The appropriate power cord for the location will be added prior to shipment.

BlueWave® MX-250

The BlueWave® MX-250 is comprised of two main parts, a controller with an easy-to-use touchscreen interface and a uniquely designed, high-intensity LED emitter. Curing energy is created using a micro-processor-controlled LED chip set in the emitter. The emitter provides a curing area of 50 mm x 50 mm but multiple systems can be grouped together to create larger curing pattern matrixes as needed.

This system's design allows it to be truly tailored to users' curing needs – allowing them to choose from three different wavelength LED emitters (365, 385, or 405 nm) and providing additional flexibility with the size and pattern of the active curing area. Users also have endless set up flexibility, as this system can be set up as a bench-top unit, or for automated curing processes, the emitter can be easily mounted to robotic arms or further from the controller without fear of intensity losses.

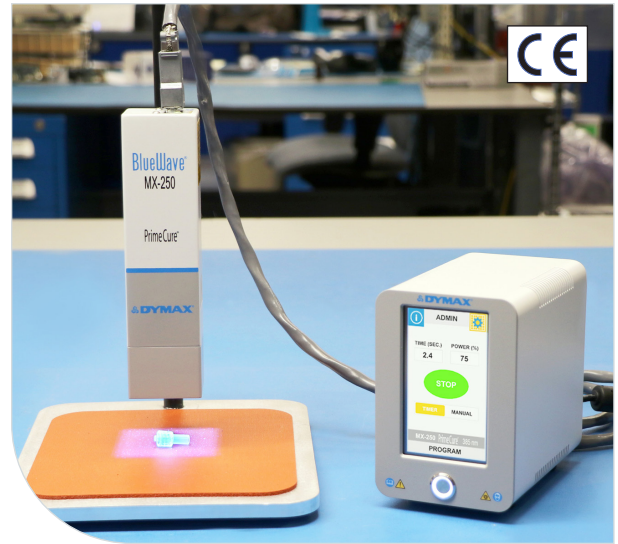

- 1.97" x 1.97" (50 mm x 50 mm) curing area with the option for multiple systems to be grouped together to create larger curing patterns
- Touchscreen interface for easier operation
- Emitter design for set up flexibility and consistent intensity
- LED emitters in 365, 385, and 405 nm wavelengths
- Admin and production modes with the ability to save curing programs for repeated use
- Instant on/off for a more energy efficient unit with no warm-up period
- PLC interface that is easily incorporated into automated systems

	RediCure 365 nm	PrimeCure 385 nm	VisiCure 405 nm
Typical Intensity Output, mW/cm ² *	255	355	375
Curing Area	1.97" x 1.97" (50 mm x 50 mm)		
Power Requirements	100 - 240 VAC ≈ 2.5 A, 50-60 Hz		

* Measured at 25-mm distance with an ACCU-CAL™ 50-LED radiometer.

A complete BlueWave MX-250 system features a controller and an LED emitter. Components are sold separately. Other accessories can be added for specific applications. See page 15 for additional accessories.

	RediCure (365 nm)	PrimeCure (385 nm)	VisiCure (405 nm)
LED Emitter	42806	42807	42808
Controllers	43184 BlueWave MX-Series 2-Channel Controller Only 43181 BlueWave MX-Series 4-Channel Controller Only 43299 BlueWave MIM Machine Interface Module Only		
Interconnect Cables	43453 Interconnect Cable Assembly (12 inches) 42287 Interconnect Cable Assembly (2 meter) 42889 Interconnect Cable Assembly (5 meter) 43010 Interconnect Cable Assembly (10 meter) 43011 Interconnect Cable Assembly (20 meter)		

NOTE: The appropriate power cord for the location will be added prior to shipment.

BlueWave® MX-275

The BlueWave® MX-275 curing system is a high-intensity LED flood-curing system. Light energy is delivered in a line pattern instead of the traditional rectangular pattern. A single BlueWave MX-275 emitter provides a 5 mm x 50 mm curing area, but when paired with a multichannel controller, up to four emitters can be used to produce a curing area as large as 5 mm x 200 mm.

BlueWave MX-275 system emitters are available in three different wavelengths: 365, 385 and 405 nm. Emitters can be set up as a bench-top unit, on an array stand to create extended line patterns, or installed on automated curing processing equipment for maximum flexibility.



	RediCure 365 nm	PrimeCure 385 nm	VisiCure 405 nm
Typical Intensity Output, mW/cm ² *	1,460	1,870	1,750
Curing Area	0.20" x 1.97" (5 mm x 50 mm)		
Power Requirements	100 - 240 VAC ≈ 2.5 A, 50-60Hz		

* Measured at a working distance of 10 mm using a Dymax ACCU-CAL™ 50-LED Radiometer with 3-mm aperture set to corresponding light measurement mode. This is preliminary intensity data for reference, tests using flood mode without an aperture will yield different results.

- Delivers high-intensity light energy in a line pattern
- 5 mm x 50 mm cure area can be scaled up by placing emitters side-by-side to provide a large, continuous band of UV LED energy
- Up to 5 mm x 200 mm cure area when paired with 4-channel controller
- Wavelength flexibility allows co-optimization of adhesive and curing system
- Can be set up as bench-top unit, on array stand, or in automated system for maximum flexibility
- Well-suited for conveyor applications where products move under light
-

A complete BlueWave MX-275 system features a controller and an LED emitter. Each emitter requires an interconnect cable. Components are sold separately.

	RediCure (365 nm)	PrimeCure (385 nm)	VisiCure (405 nm)
Line Pattern LED Emitters	43094	43098	43102
Controllers	43184 BlueWave MX-Series 2-Channel Controller Only 43181 BlueWave MX-Series 4-Channel Controller Only 43299 BlueWave MIM Machine Interface Module Only		
Interconnect Cables	43453 Interconnect Cable Assembly (12 inches) 42287 Interconnect Cable Assembly (2 meter) 42889 Interconnect Cable Assembly (5 meter) 43010 Interconnect Cable Assembly (10 meter) 43011 Interconnect Cable Assembly (20 meter)		

NOTE: The appropriate power cord for the location will be added prior to shipment.

Handlamp 250

The HL250 is a versatile, handheld UV curing lamp designed to provide reliable curing of light-curable adhesives and coatings. This system is comprised of two main parts, a high-performance 250 W handheld UV lamp and a separate power supply unit. It is portable and lightweight, weighing only 1.4 kg, making it ideally suited for mobile applications.

In addition to curing, this system can also be outfitted with a black light filter and used for fluorescent examination in quality control applications.

- Lightweight, portable curing unit
- Black filter glass available for use in quality inspections
- Wire mesh over filter glass for added user protection
-



Part Numbers	HL250 Handlamp 250 HL250BL Handlamp 250 with Black Light Filter
Light Source	UV Handlamp
Input Power	250 W
Intensity in the UVA Range	20-30 mW/cm ²
Weight of Lamp	1.4 kg
Weight of Operating Unit	2.8 kg

Accessories

Dymax light-curing flood lamps can be outfitted with the shutters and shielding shown below. Additional shutters, enclosures, and accessories may be available.

Mounting Stands

41268 Standard Mounting Stand

A simple and cost effective mounting stand with adjustable height. Includes an acrylic back shield.

BlueWave® AX-550

43410 BlueWave® AX-550 Mounting Stand

Stand with acrylic back-shield. Includes mounting carriage PN 60036.

60036 BlueWave® AX-550 Mounting Carriage

Mounting carriage to mount the BlueWave® AX-550 on stand PN 41268.

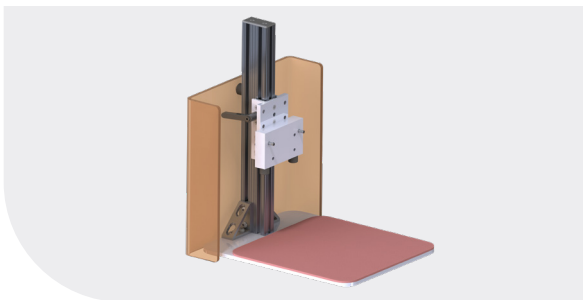

BlueWave® AX-550 Mounting Stand

BlueWave® FX-1250

88844 BlueWave® FX-1250 Mounting Stand

Stand with acrylic back-shield. Includes mounting carriage PN 60036.



BlueWave® FX-1250 Mounting Stand

BlueWave® MX-Series

42909 Single Emitter Mounting Kit

Mounting adapter for attaching MX-series emitters.

42390 Single Emitter Mounting Stand

Mounting stand with adjustable height for a single MX emitter.



Single Emitter Mounting Stand

43019 Multiple Emitter Mounting Kit

Works with stand PN 41268.

43070 Multi-Emitter Stand with Acrylic Back Shield

Mounting stand with acrylic back shield for multiple MX emitters. Works with stand PN 41395.



Multi-Emitter Mounting Stand with Acrylic Back Shield

42426 Single Emitter Mount for MX Controller

Securely mount one emitter to the side of the MX controller.

60868 Dual Emitter Mount for MX Controller

Securely mount up to two emitters to the side of the MX controller.

Shielding

Dymax offers several standard shielding options for flood lamps. All shields are 100% UVA blocking and visibly tinted.

40785 ECE Flood Light Shield

360° shielding with lifting door and sliding curing shelf. Safety Interlock feature included. Compatible with Dymax shutters.

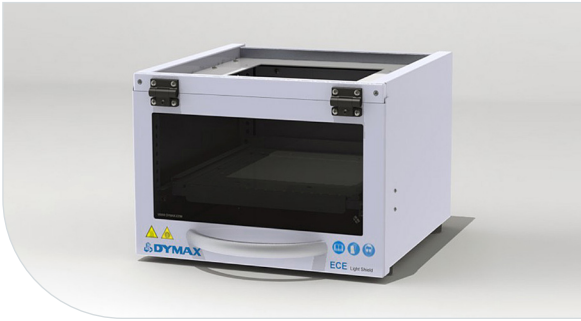

ECE Flood Light Shield

60419 BlueWave® AX-550 Light Shield

360° shielding with a swing-up door and slide-out shelf.

88845 BlueWave® FX-1250 Light Shield

360° shielding with a swing-up door and slide-out shelf. Not compatible with Dymax shutters.

41395 3-Sided Acrylic Shield

A simple and cost effective 3-sided shield that is removed manually. Compatible with BlueWave® MX-250 systems.



3-Sided Acrylic Shield

81016 3-Sided Acrylic Shield

A simple and cost effective 3-sided shield that is removed manually. Compatible with the BlueWave® FX-1250.

Shutters

Turning a bulb off and on between cycles is not practical since each off/on cycle shortens bulb life and requires a 5-minute warm-up period. A shutter, however, can be used to shield a flood system between cycles. Shutters control exposure time, reduce heat on the work surface, and shield operators from exposure to UV light. Dymax carries two types of shutters, ZIP™ and manual.

40885 ZIP™ Shutter (ECE Floods)

Timed and manual modes. Foot pedal or PLC controlled.

35572 Manual Shutter (EC & ECE Floods)

Most cost-effective shutter system.

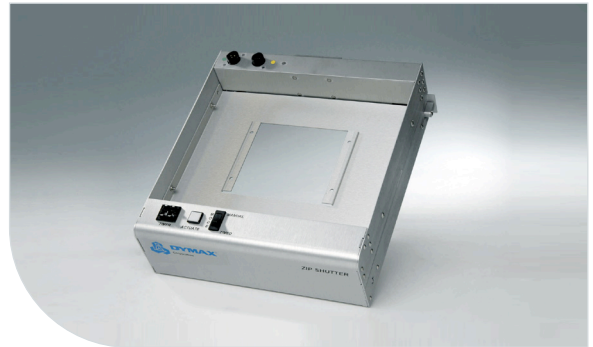

ZIP® Shutter (ECE Floods)

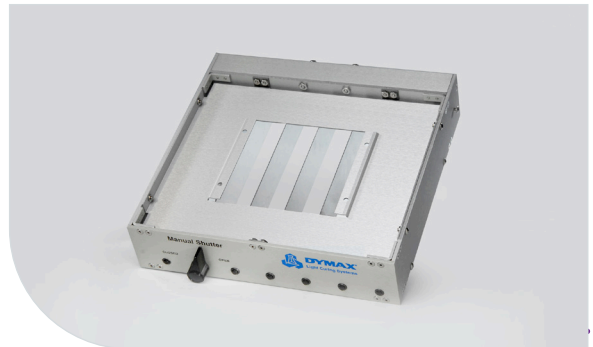

Manual Shutter

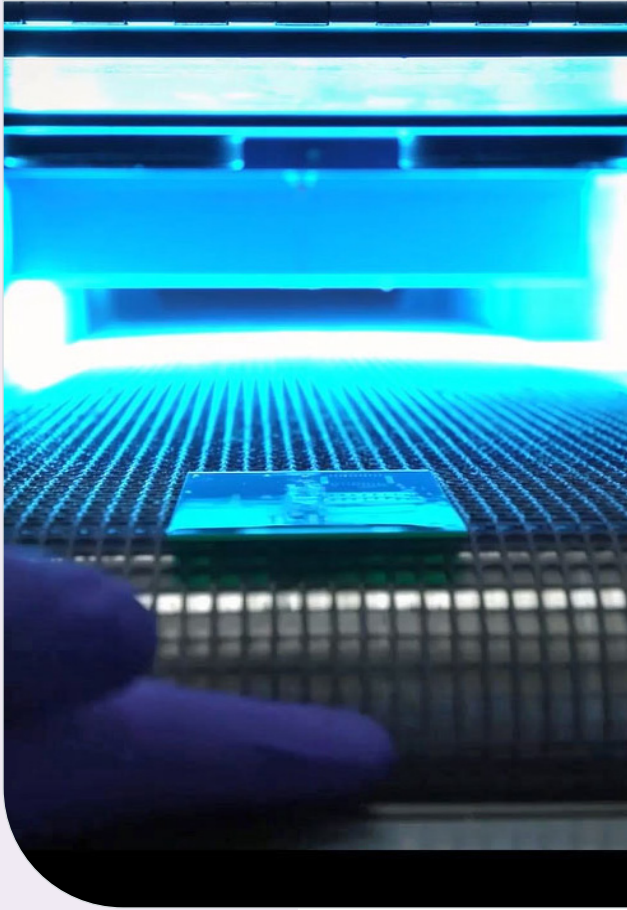

UV Broad-Spectrum & Conveyor Systems

Dymax conveyor systems are designed to offer consistent, fast, and safe curing. The systems are extremely easy to use and keep users safe by offering complete shielding from UV light. Consistent belt transport speed, adjustable lamp height, and stable lamp intensity provide a consistent light-curing process for repeatable process and optimized throughput.

Dymax UVC-series conveyor systems are an ideal choice for manufacturers who need to cure light-curable adhesives, coatings, and inks on larger parts or on large quantities of smaller parts. UVC systems are available in two models: the UVC-5, a smaller bench-top conveyor, and the UVC-8, a full size, free standing conveyor. These cost-efficient and versatile light-curing systems are perfect for use in labs or manufacturing environments.

Advantages of UVC Conveyor Systems

- Fast cures for high throughput
- Dependable, heavy-duty conveyor design
- Fully shielded lamp enclosures for operator safety
- Three bulb options available for customized curing

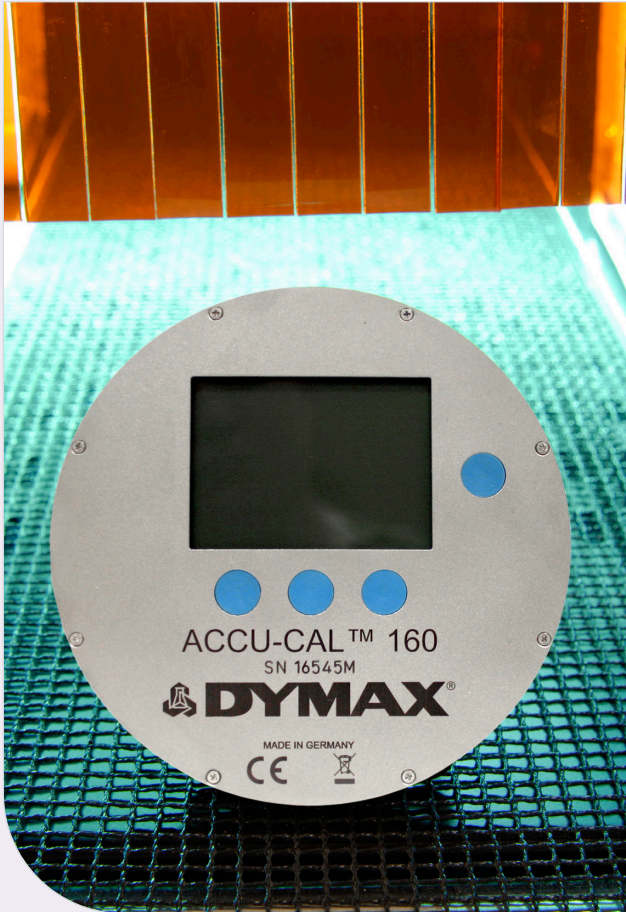

Radiometers for Spot, Flood, and Conveyor Systems

Radiometers measure the intensity of energy at specific wavelengths. UV light is, by definition, not visible to the human eye, so a radiometer is required to determine the amount of UV energy. The ability to measure light intensity is useful for three reasons:

- **Maintaining a light-curing process** – A radiometer can measure whether a light-curing system is providing intensity above the “bulb change” intensity. A radiometer is to a light-curing process what a thermometer is to a heat-curing process.
- **Providing a worker-friendly light-curing process** – A radiometer is required to determine if any UV light is reaching operators or bystanders.
- **Measuring transmission rates through substrates** – A radiometer can be used to measure the transmission rates of various wavelengths through substrates that absorb UV and/or visible light. To assure an effective curing process it is critical to measure the light intensity reaching the light-curable material below the intervening substrate.

Dymax ACCU-CAL™ Radiometers

Dymax offers ACCU-CAL™ radiometers for spots, floods, and conveyors. Kits for spot lamps include the complete radiometer with 3, 5, and 8-mm lightguide adapters and a lightguide simulator. Adapter kits are available separately for users who have an existing flood/conveyor kit and need to use it for spot systems. All radiometer kits include a storage/carrying case. ACCU-CAL™ radiometers are calibrated to measure either UV-A (320-390 nm), LED (~ 350-450 nm), or visible (395 nm to 465 nm) light intensity.

Radiometer Calibration

To ensure accurate readings, radiometers should be periodically calibrated. Calibration requirements differ from one model to another but calibration is typically required every six or twelve months. Please refer the Dymax Radiometer Calibration Schedule, available for download on our website, for the calibration requirements for your specific radiometer model. Calibration services are available through Dymax and can be scheduled by submitting the Calibration Request Form found on the dymax website or by contacting your local Dymax Customer Support Team.

UVC-5 Conveyor

The Dymax UVC-5 Conveyor is designed for curing UV/Visible light-curable adhesives, coatings, and inks in a wide range of industries. This unit is ideal for curing smaller parts and can cure materials applied to a variety of substrates such as paper, plastic, metal, glass, laminated materials, printed circuit boards, and many others.

The UVC-5 Conveyor is equipped with a 120-mm wide PTFE coated non-stick belt and one UV lamp. The distance between the lamp and the belt can be manually adjusted (between 15-60 mm) as can the belt speed (2-26 m/min). This enables the operator to tailor curing conditions to specific application requirements. The conveyor also features a counter to track hours of operation, an electric control unit located in the transportation device, and an air-cooled casing with an aluminum reflector for the bulb.



- Maintenance-free, PTFE coated non-stick belt with adjustable belt drive (2-26 m/min range)
- Adjustable vertical clearance (15 - 60 mm)
- Fully shielded lamp enclosures for optimum protection
- High power lamp (910 or 800 W) with two bulb options

Electrical Requirements	230VAC / 50 Hz 5.9A
Number of Lamps	1
Lamp Power	910W / Fe (800W / Hg) Full: 920W Half: 450W
Intensity*	400 mW/cm ² at a distance of 60 mm
Vertical Clearance	Adjustable 15-60 mm
Overall Dimensions (W x L x H)	369 mm x 700 mm x 299 mm
Belt Material	PTFE-coated fiberglass
Belt Width	120 mm
Belt Speed	Adjustable from 2-26 m/min
Vacuum Belt	Yes
Bulbs	Metal Halide (Fe) - Standard Mercury (Hg)
Net Weight	20 kg

*Measured with a Dymax ACCU-CAL™ 50 Radiometer (320-395 nm).

UVCS V3.0 LED Conveyor

The UVCS V3.0 LED is a modernized conveyor packed with features for ease of use and the best quality of life. It is designed to function with Dymax's BlueWave® FX-1250 LED flood emitters, and can be configured in various mounting arrangements including single lamp, 1x3 arrays, or 2x2 arrays. With a belt width of 300 mm, the UVCS V3.0 LED can operate at speeds from 0.4 m - 7.8 m/min, and is capable of reversible operation. Additionally, integrated sensors detect when parts enter and exit the curing tunnel, automatically toggling emitters on/off to ensure accurate process timing.

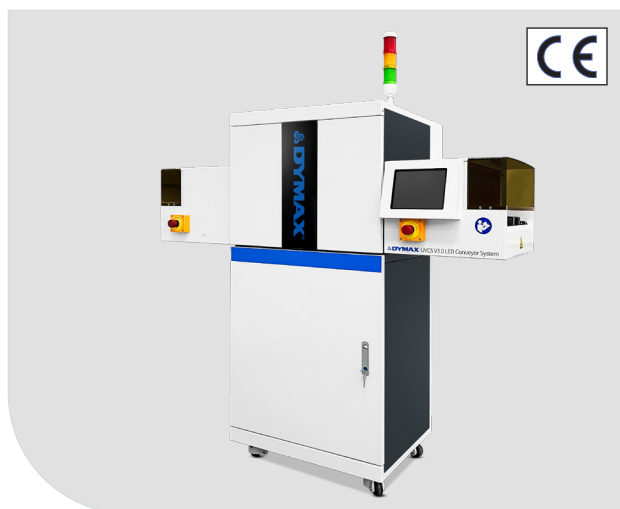

- 200 mm touchscreen with modern UI
- Automatic part sensing
- Multiple operating modes including high-speed conveying, static oven, and PLC mode
- Reversible conveyor belt operation
- Low ESD for electronics applications

UVCS V3.0 LED Conveyor, Base	North American (110V)	Asian (220V)	European (220V)
H-Cradle Configuration	88880	88884	88888
V-Cradle Configuration	88881	88885	88889
Accessories			
Cabinet	80020		
Emitter Cradles	80021 Horizontal Configuration 80022 Vertical Configuration		

North American: Type B Power Cord
 Asian: Type I Power Cord
 European: Type F Power Cord

UVCS V3.0 LED Conveyor		
Conveyor Voltage	220V	110V
Amperage (With Emitters)	1.5A	3A
Belt Width	300 mm (12")	
Belt Speed	0,4 m/min ~ 7,8 m/min, in 0,1 m/min increments	
Load Capacity	Left to Right: 25 kg max. Right to Left: 25 kg max	
Emitter Adjustment Range	(12 - 152 mm)	
Noise Level	65dBa (One emitter, fan speed setting 2)	
Operating Conditions	+10 to +40°C, 0-80% relative humidity, non-condensing	
Storage Temperature	-20 to +50°C	
Weight (Conveyor Only)	90 kg	
Crated Dimensions (L x W x H)	1730 x 1046 x 795 mm	
Regulatory	CE, RoHS, Machinery Directive, UKCA, China GB4793.1-2007	

UVC-8 Conveyor

The Dymax UVC-8 Conveyor is designed for curing UV/Visible light-curable adhesives, coatings, and inks. This cost-efficient and versatile conveyor system is perfect for both production and lab environments, and can be used in a number of different industries. Typical substrates that are bonded, coated, or encapsulated include paper, plastic, metal, glass, laminated materials, printed circuit boards, and many others.

The UVC-8 Conveyor is equipped with a 220-mm wide PTFE coated non-stick belt and can be outfitted with one, two, or three UV lamps. The distance between the lamp and the belt can be manually adjusted (between 60-100 mm) as well as the belt speed (0.5-12 m/min). This enables the operator to tailor the curing conditions to the specific application. The conveyor also features a digital control panel where various parameters such as operating hours, lamp current, and the UV set point can be monitored.



- Maintenance-free, PTFE coated non-stick belt with adjustable belt drive (0.5-12 m/min range)
- Fully shielded lamp enclosures for optimum protection
- Lamp height adjustment (60 – 100 mm) to accommodate various part heights
- Optional intensity adjustment (40-100%)
- Digital control panel, compact PLC

Electrical Requirements	3 x 400V/N/PE, 50 Hz
Number of Lamps	1, 2, or 3 UV lamps
Lamp Power	2000 W per bulb
Intensity*	800 mW/cm ² at a distance of 60 mm
Vertical Clearance	Adjustable 60-100 mm
Overall Dimensions (W x L x H)	1,100 mm x 1,000 mm x 1,200 mm
Working Height (Floor to Belt)	900 mm on wheel kit or 900 - 950 mm with adjustable screws
Control	Compact PLC
Belt Material	PTFE-coated fiberglass
Belt Width	220 mm
Belt Speed	Adjustable from 0.5-12 m/min
Bulbs	Metal Halide (Fe) - Standard Mercury (Hg) Gallium (Ga)
Air Exhaust	500 m ³ /h
Net Weight	180 kg

*Measured with a Dymax ACCU-CAL™ 50 Radiometer (320-395 nm).

ACCU-CAL™ 50

The ACCU-CAL™ 50 radiometer is simple to operate and offers repeatable measurement of UV light. The ACCU-CAL™ 50 can measure UV light emitted from lightguides (3, 5, and 8 mm), UV flood systems, and UV conveyors. With a spectral sensitivity from 320 to 395 nm (UVA), the ACCU-CAL™ 50 measures intensities from 1 mW/cm² to 40 W/cm². A specially designed photo-sensor assembly protects the photo-sensor from the high temperatures sometimes associated with today's high intensity UV spot lamps.

39561 ACCU-CAL™ 50 for flood lamps and conveyors

Complete radiometer (without lightguide adapters or lightguide simulator*); includes storage/carrying case.

39560 ACCU-CAL™ 50 for spots, floods, and conveyors

Complete radiometer with lightguide adapters (3, 5, and 8 mm) and lightguide simulator*; includes storage/carrying case.



- Spectral sensitivity of 320-395 nm
- 12 month calibration cycle
- Can be used to test spot or flood lamps, as well as conveyor systems
- Set screw locks lightguide in place
- PTB and NIST traceable

ACCU-CAL™ 50V

The ACCU-CAL™ 50V radiometer is simple to operate and offers repeatable measurement of visible light. The ACCU-CAL™ 50V can measure visible light energy emitted from lightguides (3, 5, and 8 mm), flood systems, and conveyors. With a spectral sensitivity from 400 to 470 nm (blue portion of the visible spectrum), the ACCU-CAL™ 50V measures intensities from 1 mW/cm² to 40 W/cm². A specially designed photo sensor assembly protects the photo sensor from the high temperatures sometimes associated with today's high-intensity spot lamps.

40044 ACCU-CAL™ 50V for flood lamps and conveyors

Complete radiometer (without lightguide adapters or lightguide simulator*); includes storage/carrying case.

40043 ACCU-CAL™ 50V for spots, floods, and conveyors

Complete radiometer with lightguide adapters (3, 5, and 8 mm) and lightguide simulator*; includes storage/carrying case.



- Spectral sensitivity of 400-470 nm (visible)
- 12 month calibration cycle
- Can be used to test spot or flood lamps, as well as conveyor systems
- Set screw locks lightguide in place
- PTB and NIST traceable

*A lightguide simulator is used to measure direct spot lamp intensity (required to calculate lightguide transmission)

ACCU-CAL™ 50-LED

The ACCU-CAL™ 50-LED radiometer is simple to operate and offers accurate measurement of curing energy. The ACCU-CAL™ 50-LED can measure energy levels emitted from lightguides (3, 5, and 8 mm), BlueWave QX4 LED heads, LED flood lamps, and line-pattern curing systems. A spectral sensitivity range of 350 - 450 nm and intensity measurement from 1 mW/cm² to 40 W/cm², makes this unit ideal for measuring LED curing source energy levels. A specially designed photo-sensor assembly provides repeatable measurements and protection from high temperatures associated with some LED systems on the market.

40505 ACCU-CAL™ 50-LED for LED spot and flood units

Complete radiometer with 3, 5, and 8 mm lightguide adapters, lightguide simulator*, and an optical adapter for use with the BlueWave QX4 and BlueWave MX-275; includes storage/carrying case.

40519 - ACCU-CAL™ 50-LED for LED floods and conveyors

Complete radiometer (without lightguide adapters or lightguide simulator*); includes storage/carrying case.

39554 Flood-to-Spot Adapter Kit

Kit includes three lightguide adapters (3, 5, and 8 mm) and a lightguide simulator.

42218 BlueWave QX4 Optic Adapter Upgrade Kit

Kit includes the optic adapter and updated software and calibration for an existing radiometer. The customer's radiometer must be returned to Dymax for programming and calibration.

43383 Line Optic Adapter Upgrade Kit for the BlueWave QX4 and BlueWave MX-275

Kit includes the optic adapter and updated software to allow your radiometer to measure line-pattern systems. It also includes calibration for your existing radiometer. The customer's radiometer must be returned to Dymax for programming and calibration.



- Spectral sensitivity of 360-450 nm
- 12 month calibration cycle
- Can be used to test spot or flood lamps, as well as conveyor systems
- Set screw locks lightguide in place
- PTB and NIST traceable

*A lightguide simulator is used to measure direct spot lamp intensity (required to calculate lightguide transmission)

ACCU-CAL™ 160

The ACCU-CAL™ 160 radiometer is available in both a UV and LED model and can measure UV or LED light up to 10 W/cm² emitted from stationary light-curing flood lamps or lamps used in conveyorized processes. This radiometer can be used to determine intensity (measured in mW/cm²) or total energy as derived from intensity and exposure time (measured in mJ/cm²). The ACCU-CAL™ 160 offers a number of improved features and benefits including a longer calibration cycle (12 months instead of 6), an easier-to-use set-up screen, and a graphical display that is clearer and easier-to-read. The unit is simple to operate and can be controlled via four buttons on the faceplate. Measurement results are displayed on the integrated LCD display or transmitted by the USB interface to a computer. A data download kit is included with each radiometer at no charge and downloads easily into Microsoft Excel.

41590 ACCU-CAL™ 160 UVA

41585 ACCU-CAL™ 160 LED



- LED or UVA models available
- Spectral sensitivity of 328-382 nm (UVA model) or 350-460 nm (LED model)
- 12 month calibration cycle
- +/- 0.5 accuracy
- Clear, easy-to-read graphical display
- For use with flood lamp or conveyor systems

*A lightguide simulator is used to measure direct spot lamp intensity (required to calculate lightguide transmission)



Equipment Programs

Take advantage of the opportunity to evaluate Dymax equipment with our Try & Buy Program or upgrade your existing light-curing equipment using our new Trade-In Program.

Try & Buy: Dymax Try & Buy is a low-risk way to evaluate Dymax equipment in your application before purchasing it. After the two-week trial period, rental of the unit will be billed monthly. Typically, after six payments, the system is yours to keep. This program applies to curing and dispense equipment systems only, and excludes all consumable parts and accessories.

Trade-In: Upgrade your existing light-curing equipment to the latest Dymax model regardless of what brand you're using today. The program allows one trade-in per purchase of a new, full price piece of Dymax equipment. Conditions and exclusions apply.

For more information, reach out to Dymax Customer Support or submit an application online at dymax.com/sales-support/contact-us.



www.dymax.com

Americas

USA | +1.860.482.1010 | info@dymax.com

Europe

Germany | +49 611.962.7900 | info_de@dymax.com
Ireland | +353 21.237.3016 | info_ie@dymax.com

Asia

Singapore | +65.67522887 | info_ap@dymax.com
Shenzhen | +86.755.83485759 | info@hanarey.com
Hong Kong | +852.2460.7038 | dymaxasia@dymax.com
Korea | +82.31.608.3434 | info_kr@dymax.com

©2021-2024 Dymax Corporation. All rights reserved. All trademarks in this guide, except where noted, are the property of, or used under license by, Dymax Corporation, U.S.A.

The data contained in this bulletin is of a general nature and is based on laboratory test conditions. Dymax Europe GmbH does not warrant the data contained in this bulletin. Any warranty applicable to products, its application and use is strictly limited to that contained in Dymax Europe GmbH's General Terms and Conditions of Sale published on our website. Dymax Europe GmbH does not assume any responsibility for test or performance results obtained by users. It is the user's responsibility to determine the suitability for the product application and purposes and the suitability for use in the user's intended manufacturing apparatus and methods. The user should adopt such precautions and use guidelines as may be reasonably advisable or necessary for the protection of property and persons. Nothing in this bulletin shall act as a representation that the product use or application will not infringe a patent owned by someone other than Dymax Corporation or act as a grant of license under any Dymax Corporation Patent. Dymax Europe GmbH recommends that each user adequately test its proposed use and application of the products before actual repetitive use, using the data contained in this bulletin as a general guide.

SG014EU 14/10/2024